



PS-121000S **12V 100.0 AH @ 20-hr.** **12V 95.2 AH @ 10-hr.**

Rechargeable Sealed Lead Acid Battery
PS – General Purpose Series

TERMINALS: (mm)

T6: Threaded insert with 6mm stud fastener

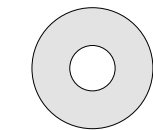
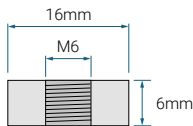

Torque: 3.9~5.4 Nxm

U: Universal terminals: Heavy-duty posts with 'nut & bolt' fasteners

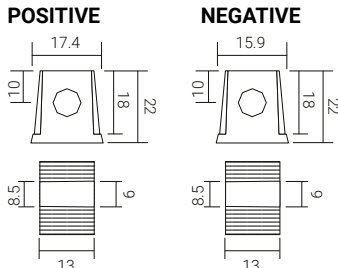

Torque: 11.0~14.7 Nxm

FEATURES

- 10 – 12 year design life
- Absorbent Glass Mat (AGM) technology for superior performance
- Valve regulated, maintenance free spill proof construction
- Power/volume ratio yielding excellent energy density
- Rugged vibration and impact resistant ABS case and cover
- Gas recombination technology

APPROVALS

- Approved for transport by air. D.O.T., I.A.T.A., F.A.A. and C.A.B. certified
- U.L. recognized
- ISO9001:2015 – Quality management systems

DIMENSIONS: inch (mm)

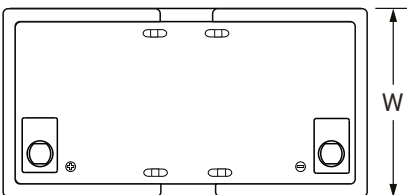

L: 12.00 (305)
W: 6.60 (168)
H: 8.15 (207)
HT: 8.98 (228)

Tolerances are +/- 0.04 in. (+/- 1mm) and +/- 0.08 in. (+/- 2mm) for height dimensions. All data subject to change without notice.

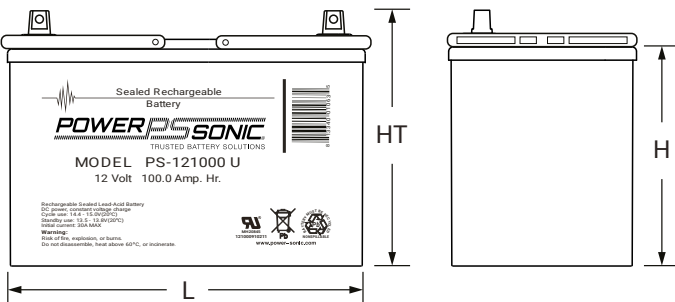

PERFORMANCE SPECIFICATIONS

Nominal Voltage	12 volts (6 cells)
Nominal Capacity	
20-hr. (5.00A to 10.50 volts)	100.0 AH
10-hr. (9.52A to 10.50 volts)	95.2 AH
5-hr. (16.6A to 10.20 volts)	83.0 AH
1-hr. (57.9A to 9.00 volts)	57.9 AH
Approximate Weight	67.5 lbs. (30.6 kg)
Internal Resistance (approx.)	4.9 milliohms
Max Short-Duration Discharge Current (10 Sec.)	750.0 amperes
Shelf Life (% of nominal capacity at 68°F (20°C))	
1 Month	97%
3 Month	91%
6 Month	83%
Operating Temperature Range	
Charge	5°F (-15°C) to 122°F (50°C)
Discharge	-4°F (-20°C) to 140°F (60°C)
Case	ABS Plastic
Power Sonic Chargers	PSC-1210000A-C PSC-1210000-PC PSC-1220000-PC

CORPORATE HEADQUARTERS (USA AND INTERNATIONAL EXCLUDING EMEA)

Power-Sonic Corporation
7550 Panasonic Way, San Diego,
California 92154
T: +1 (619) 661 2020
F: +1 (619) 661 3650
E: customer-service@power-sonic.com

POWER-SONIC EUROPE LIMITED (EMEA – EUROPE, MIDDLE EAST AND AFRICA)

3 Buckingham Square,
Hurricane Way, Wickford,
Essex SS11 8YQ
T: +44 (0)1268 560686
F: +44 (0)1268 560902
E: salesEMEA@power-sonic.com

PS-121000S 12V 100.0 AH @ 20-hr.
12V 95.2 AH @ 10-hr.

Rechargeable Sealed Lead Acid Battery
PS – General Purpose Series

SHELF LIFE & STORAGE

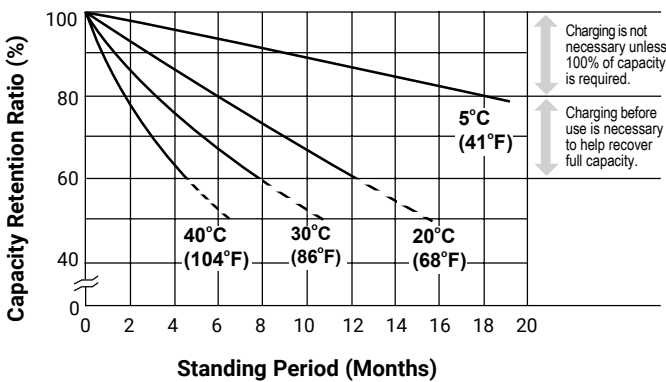

LIFE CHARACTERISTICS IN STAND-BY USE

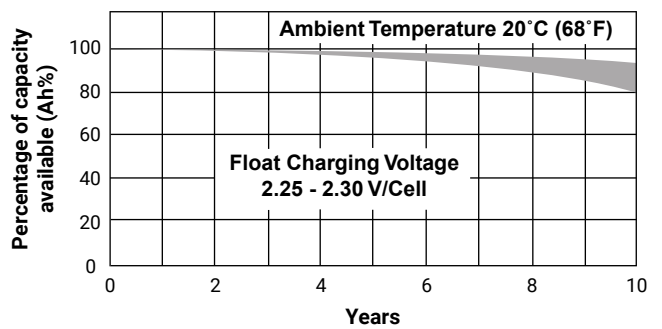

CHARGING

Cycle Applications: Apply constant voltage charge at 2.35v/c – 2.45v/c (14.1 – 14.7v for 12v Monobloc) at 20°C. Initial charging current should be set at less than 0.25C Amps. Switch to float charge to avoid overcharging.

“Float” or “Stand-By” Service: Apply constant voltage charge of 2.25v/c – 2.30v/c (13.5 to 13.8 volts for 12v Monobloc) at 20°C. When held at this voltage, the battery will seek its own current level and maintain itself in a fully charged condition.

Temperature Compensation: Charging Voltage for both Cyclic and Standby applications should be regulated in relation to ambient temperature. As temperature rises charging voltage should be reduced to prevent overcharge and increased as temperature falls to avoid undercharge.

For further charging information including temperature compensation factors, see Power Sonic Technical Manual/ Power Sonic Charger specifications.

APPLICATIONS

- General purpose
- Medical
- Emergency lighting
- Fire and security

CORPORATE HEADQUARTERS
(USA AND INTERNATIONAL EXCLUDING EMEA)

Power-Sonic Corporation
7550 Panasonic Way, San Diego,
California 92154
T: +1 (619) 661 2020
F: +1 (619) 661 3650
E: customer-service@power-sonic.com

POWER-SONIC EUROPE LIMITED
(EMEA – EUROPE, MIDDLE EAST AND AFRICA)

3 Buckingham Square,
Hurricane Way, Wickford,
Essex SS11 8YQ
T: +44 (0)1268 560686
F: +44 (0)1268 560902
E: salesEMEA@power-sonic.com

CHARGERS

Power Sonic offers a wide range of chargers suitable for batteries with a variety of capacities.

Please refer to our website for more information on our switch mode and transformer type chargers.

Please contact our technical department for advice if you have difficulty in locating a suitable charger.

FURTHER INFORMATION

Please refer to our website www.power-sonic.com for a complete range of useful downloads, such as product catalogs, material safety data sheets (MSDS), ISO certification, etc.

